















# “Mavi Seri” Baca Sistemleri













# "MAVİ SERİ" KONVANSİYONEL KOMBİ BACA AKSESUARLARI

(Ø 60/100)	Ürün Adı	Kod	Vadeli Fiyat (120 gün)
	(Ø 60/100) Eşmerkezli Yatay Set	4.017736	29 €
	(Ø 60/100) Eşmerkezli Yatay Buzlanmaya Karşı Baca Seti	4.018210	57 €
	(Ø 60/100) Eşmerkezli Dikey Set	4.011698	47 €
	(Ø 60/100) Flanşlı dikey tahliye adaptörü	3.011141	38 €
	(60/100) Flanşlı 90° dirsek	4.011139	19 €
	(Ø 60/100) 0,5 m baca uzatma borusu	4.018278	16 €
	(Ø 60/100) 1,0 m baca uzatma borusu	4.018277	23 €
	(Ø 60/100) 2,0 m baca uzatma borusu	4.010739	45 €
	(Ø 60/100) 90° dirsek	4.018279	20 €
	(Ø 60/100) 45° dirsek	4.010950	17 €
	(Ø 60/100) Yoğuşuk tahliye adaptörü	4.016173	47 €

## "MAVİ SERİ" KONVANSİYONEL KOMBİ BACA AKSESUARLARI

(Ø 80/125)	Ürün Adı	Kod	Vadeli Fiyat (120 gün)
	(Ø 80 /125) Eşmerkezli Yatay Set	4.010526	100 €
	(Ø 80 /125) Eşmerkezli Dikey Set	4.010352	186 €
	(Ø 80 /125) 0,5 m Baca Uzatma Borusu	4.011157	31 €
	(Ø 80 /125) 1,0 m Baca Uzatma Borusu	4.010945	53 €
	(Ø 80 /125) 2,0 m Baca Uzatma Borusu	4.010946	90 €
	(Ø 80 /125) 90° Dirsek	4.010951	25 €
	(Ø 80 /125) 45° Dirsek	4.010952	32 €
	(Ø 80 /125) Yoğuşuk Tahliye Adaptörü	4.010960	30 €
<b>(Ø 80+80)</b>			
	(Ø 80+80) Ayrık baca seti	4.010351	86 €

## "MAVİ SERİ" KONVANSİYONEL KOMBİ BACA AKSESUARLARI

(Ø 80+80)	Ürün Adı	Kod	Vadeli Fiyat (120 gün)
	(Ø 80/125) Dikey atık gaz tahliye komple kiti	3.010963	354 €
	(Ø 80+Ø 80) Flanşlı dikey tahliye adaptör kiti	4.011570	35 €
	(Ø 80) 1,0 m baca uzatma borusu (4adet)	4.010741	16 €
	(Ø 80) 2,0 m baca uzatma borusu (1 adet)	4.011167	27 €
	(Ø 80) 90° dirsek (4 adet)	3.010955	90 €
	(Ø 80) 45° dirsek (4 adet)	3.010956	27 €
	(Ø 80) 90° dişi / dişi dirsek	3.011571	30 €
	(Ø 80) Yoğuşuk tahliye adaptörü	3.012009	36 €
	(Ø 80) Baca dişi / dişi dikey geçiş adaptörü	3.012714	23 €
	(Ø 80) Atık gaz tahliye rüzgar kafesi	3.010962	31 €
	Dikey çıkış siperlik	3.011488	61 €

Atık Gaz/Temiz Hava Baca Setleri  
Konvansiyonel Kombiler ve Kat Kalfiferleri İin

Ø 60 / 100 Yatay  
Eşmerkezli Baca Seti

Ø 60 / 100 Dikey  
Eşmerkezli Baca Seti

Ø 80 / 80 Ayrık Baca Seti  
Temiz hava emiři ve atık gaz  
iin ayrı baca sistemi

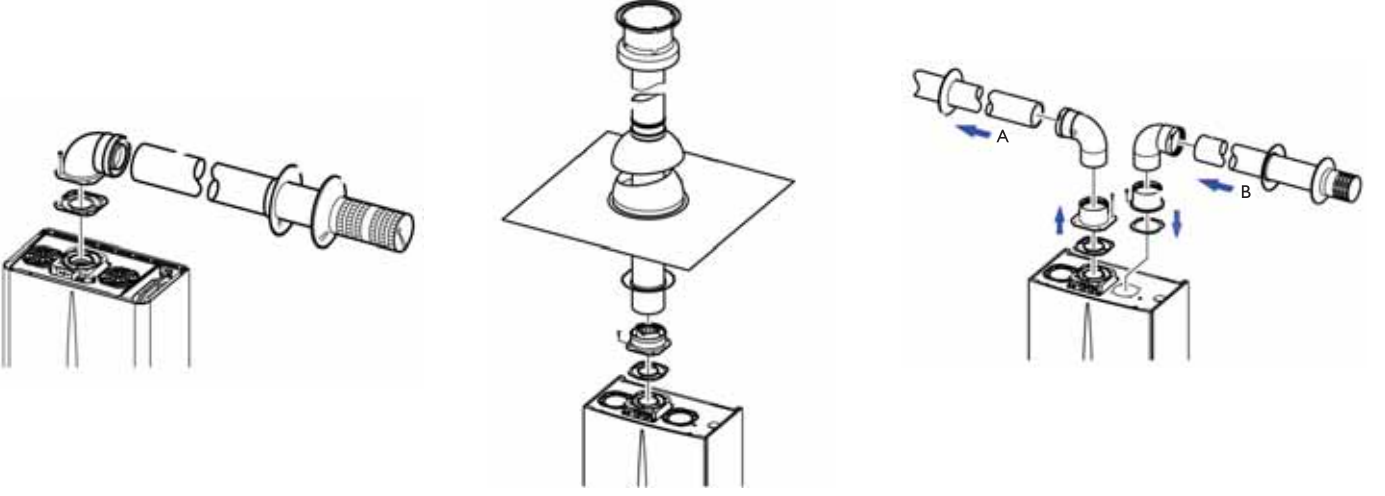

Yatay Eşmerkezli Baca Montajı

Dikey Eşmerkezli Baca Montajı

Ø 60 / 100 mm

Ø 60 / 100 mm

Ø 80 / 125 mm

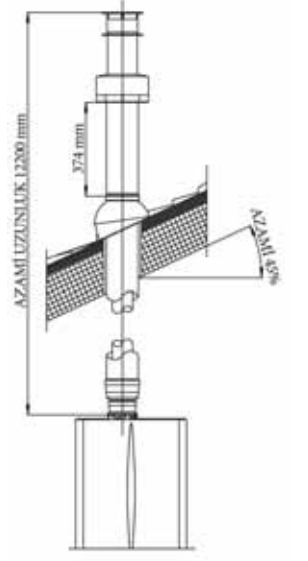
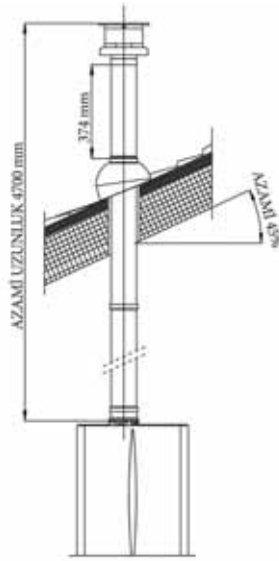
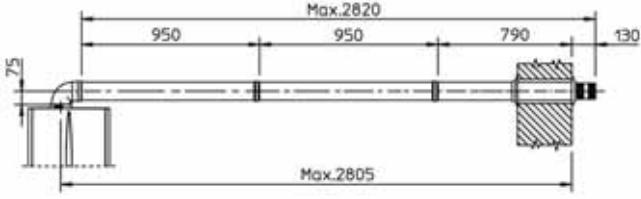

Ø 80 / 125 mm

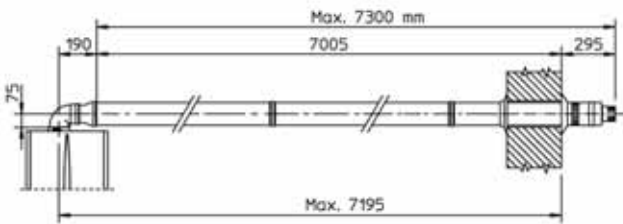

Ø 80 + Ø 80 mm

Ayrık Baca Sistemi Baca Mesafeleri

Atık Gaz Baca Mesafesi	Temiz Hava Baca Mesafesi
1	36.0*
2	34.5*
3	33.0*
4	32.0*
5	30.5*